

# XLamp® XH-G LED

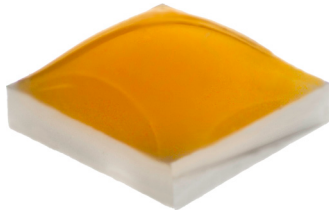

## PRODUCT DESCRIPTION

Unlike common plastic packages, XLamp XH LEDs use a ceramic package to deliver the unique combination of high performance and reliability not available elsewhere in mid-power LEDs. The ceramic-based XH LEDs are designed to deliver the long L70 lifetimes of Cree LED's other high-power LEDs, such as XP or XT LEDs, as well as industry-leading LED efficacy levels.

Optimized for fluorescent replacement lighting applications, such as troffers and panel lights, where high efficacy, long lifetime and smooth appearance are critical, the XH LEDs allow lighting manufacturers to offer products that meet the lifetime expectations of LED technology.

## FEATURES

- Package size: 3.0 X 3.0 mm
- Available in white (2200 K and 2600 K - 8300 K), 70-minimum CRI cool white, 80-minimum CRI white and 85- and 90-minimum CRI warm white
- 350 mA maximum drive current
- Viewing angle: 130°
- Reflow solderable - JEDEC J-STD-020C compatible
- Unlimited floor life at ≤ 30 °C/85% RH
- RoHS and REACH compliant
- UL® recognized component (E349212)

## TABLE OF CONTENTS

Characteristics .....	2
Flux Characteristics .....	3
Relative Spectral Power Distribution .....	6
Relative Flux vs. Junction Temperature.....	6
Electrical Characteristics.....	7
Relative Flux vs. Current .....	7
Typical Spatial Distribution.....	8
Thermal Design .....	8
Performance Groups – Luminous Flux.....	9
Performance Groups – Chromaticity.....	9
Standard Cool White Kits Plotted on ANSI	
Standard Chromaticity Regions .....	12
Standard Warm and Neutral White Kits	
Plotted on ANSI Standard Chromaticity	
Regions .....	13
Standard Chromaticity Kits .....	14
Bin and Order Code Format.....	15
Reflow Soldering Characteristics.....	16
Notes .....	17
Mechanical Dimensions .....	19
Tape and Reel.....	20
Packaging.....	22



Cree LED / 4001 E. Hwy. 54, Suite 2000 / Durham, NC 27709 USA / +1.919.313.5330 / [www.cree-led.com](http://www.cree-led.com)

## CHARACTERISTICS

Characteristics	Unit	Minimum	Typical	Maximum
Thermal resistance, junction to solder point <sup>9</sup>	°C/W		14	
Viewing angle (FWHM)	degrees		130	
Temperature coefficient of voltage	mV/°C		-1.2	
ESD withstand voltage (HBM per Mil-Std-883D)	V			8000
DC forward current	mA			350
Reverse voltage	V			1
Forward voltage (@ 65 mA, 25 °C)	V		2.9	3.4
LED junction temperature	°C			150

### Note:

- ◇ Thermal resistance measurement was performed per the JEDEC JESD51-14 standard. See the [Thermal Resistance Measurement application note](#) for more details.

## FLUX CHARACTERISTICS (T<sub>J</sub> = 25 °C)

The following table provides several base order codes for XLamp XH-G LEDs. For a complete description of the order-code nomenclature, please consult the Bin and Order Code Format section (page 15).

Chromaticity		Minimum Luminous Flux (lm) @ 65 mA		Calculated Minimum Luminous Flux (lm)*	Order Codes		
Kit	CCT	Code	Flux (lm)	300 mA	No Minimum CRI	70 CRI Minimum	80 CRI Minimum
ANSI Cool White (5000 K – 8300 K)							
E1	6500 K	K2	30.6	115	XHGAWT-00-0000-00000L0E1	XHGAWT-00-0000-00000B0E1	
		J3	26.8	101	XHGAWT-00-0000-00000LXE1	XHGAWT-00-0000-00000BXE1	XHGAWT-00-0000-00000HXE1
50	6000 K	K2	30.6	115	XHGAWT-00-0000-00000L050	XHGAWT-00-0000-00000B050	
		J3	26.8	101	XHGAWT-00-0000-00000LX50	XHGAWT-00-0000-00000BX50	XHGAWT-00-0000-00000HX50
51	6000 K	K2	30.6	115	XHGAWT-00-0000-00000L051	XHGAWT-00-0000-00000B051	
		J3	26.8	101	XHGAWT-00-0000-00000LX51	XHGAWT-00-0000-00000BX51	XHGAWT-00-0000-00000HX51
53	5700 K	K2	30.6	115	XHGAWT-00-0000-00000L053	XHGAWT-00-0000-00000B053	
		J3	26.8	101	XHGAWT-00-0000-00000LX53	XHGAWT-00-0000-00000BX53	XHGAWT-00-0000-00000HX53
E2	5700 K	K2	30.6	115	XHGAWT-00-0000-00000L0E2	XHGAWT-00-0000-00000B0E2	
		J3	26.8	101	XHGAWT-00-0000-00000LXE2	XHGAWT-00-0000-00000BXE2	XHGAWT-00-0000-00000HXE2

### Notes

- Cree LED maintains a tolerance of ±7% on flux and power measurements, ±0.005 on chromaticity (CCx, CCy) measurements and a tolerance of ±2 on CRI measurements. See the Measurements section (page 17).
- XLamp XH-G LED order codes specify only a minimum flux bin and not a maximum. Cree LED may ship reels in flux bins higher than the minimum specified by the order code without advance notice. Shipments will always adhere to the chromaticity bin restrictions specified by the order code.
- Typical CRI for Neutral White, 3700 K - 5000 K CCT is 75.
- Typical CRI for Warm White, 2600 K - 3700 K CCT is 80.
- Minimum CRI for 70-CRI Minimum Cool White is 70.
- Minimum CRI for 80-CRI Minimum White is 80.
- Minimum CRI for 85-CRI Minimum White is 85.
- Minimum CRI for 90-CRI Minimum White is 90.
- \* Flux values @ 300 mA are calculated and for reference only.

**FLUX CHARACTERISTICS (T<sub>j</sub> = 25 °C) - CONTINUED**

Chromaticity		Minimum Luminous Flux (lm) @ 65 mA		Calculated Minimum Luminous Flux (lm)*	Order Codes		
Kit	CCT	Code	Flux (lm)	300 mA	70 CRI Minimum	75 CRI Typical	80 CRI Minimum
ANSI Neutral White (3700 K – 5000 K)							
E3	5000 K	K2	30.6	46.0	XHGAWT-00-0000-00000B0E3	XHGAWT-00-0000-00000L0E3	
		J3	26.8	40.4	XHGAWT-00-0000-00000BXE3	XHGAWT-00-0000-00000LXE3	XHGAWT-00-0000-00000HXE3
F4	4750 K	K2	30.6	46.0	XHGAWT-00-0000-00000B0F4		
		J3	26.8	40.4	XHGAWT-00-0000-00000BXF4	XHGAWT-00-0000-00000LXF4	XHGAWT-00-0000-00000HXF4
E4	4500 K	K2	30.6	46.0	XHGAWT-00-0000-00000B0E4		
		J3	26.8	40.4	XHGAWT-00-0000-00000BXE4	XHGAWT-00-0000-00000LXE4	XHGAWT-00-0000-00000HXE4
F5	4300 K	K2	30.6	46.0	XHGAWT-00-0000-00000B0F5		
		J3	26.8	40.4	XHGAWT-00-0000-00000BXF5	XHGAWT-00-0000-00000LXF5	XHGAWT-00-0000-00000HXF5
E5	4000 K	K2	30.6	46.0	XHGAWT-00-0000-00000B0E5		XHGAWT-00-0000-00000H0E5
		J3	26.8	40.4	XHGAWT-00-0000-00000BXE5	XHGAWT-00-0000-00000LXE5	XHGAWT-00-0000-00000HXE5

- Notes**
- Cree LED maintains a tolerance of ±7% on flux and power measurements, ±0.005 on chromaticity (CCx, CCy) measurements and a tolerance of ±2 on CRI measurements. See the Measurements section (page 17).
  - XLamp XH-G LED order codes specify only a minimum flux bin and not a maximum. Cree LED may ship reels in flux bins higher than the minimum specified by the order code without advance notice. Shipments will always adhere to the chromaticity bin restrictions specified by the order code.
  - Typical CRI for Neutral White, 3700 K - 5000 K CCT is 75.
  - Typical CRI for Warm White, 2600 K - 3700 K CCT is 80.
  - Minimum CRI for 70-CRI Minimum Cool White is 70.
  - Minimum CRI for 80-CRI Minimum White is 80.
  - Minimum CRI for 85-CRI Minimum White is 85.
  - Minimum CRI for 90-CRI Minimum White is 90.
  - \* Flux values @ 300 mA are calculated and for reference only.

FLUX CHARACTERISTICS (T<sub>j</sub> = 25 °C) - CONTINUED

Chromaticity		Minimum Luminous Flux (lm) @ 65 mA		Calculated Minimum Luminous Flux (lm)*	Order Codes				
Kit	CCT	Code	Flux (lm)	300 mA	70 CRI Minimum	80 CRI Typical	80 CRI Minimum	85 CRI Minimum	90 CRI Minimum
ANSI Warm White (2700 K - 3700 K)									
F6	3700 K	J3	26.8	101	XHGAWT-00-0000-00000BXF6	XHGAWT-00-0000-00000LXF6	XHGAWT-00-0000-00000HXF6		
E6	3500 K	J3	26.8	101	XHGAWT-00-0000-00000BXE6	XHGAWT-00-0000-00000LXE6	XHGAWT-00-0000-00000HXE6		
F7	3200 K	J3	26.8	101	XHGAWT-00-0000-00000BXF7	XHGAWT-00-0000-00000LXF7	XHGAWT-00-0000-00000HXF7		
		J2	23.5	88.6			XHGAWT-00-0000-00000HWF7		
		H0	18.1	68.2				XHGAWT-00-0000-00000PVF7	XHGAWT-00-0000-00000UVF7
E7	3000 K	J3	26.8	101	XHGAWT-00-0000-00000BXE7	XHGAWT-00-0000-00000LXE7	XHGAWT-00-0000-00000HXE7		
		J2	23.5	88.6			XHGAWT-00-0000-00000HWE7		
		H0	18.1	68.2				XHGAWT-00-0000-00000PVE7	XHGAWT-00-0000-00000UVE7
F8	2850 K	J3	26.8	101	XHGAWT-00-0000-00000BXF8	XHGAWT-00-0000-00000LXF8	XHGAWT-00-0000-00000HXF8		
		J2	23.5	88.6		XHGAWT-00-0000-00000LWF8	XHGAWT-00-0000-00000HWF8		
		H0	18.1	68.2				XHGAWT-00-0000-00000PVF8	XHGAWT-00-0000-00000UVF8
E8	2700 K	J3	26.8	101	XHGAWT-00-0000-00000BXE8	XHGAWT-00-0000-00000LXE8	XHGAWT-00-0000-00000HXE8		
		J2	23.5	88.6		XHGAWT-00-0000-00000LWE8	XHGAWT-00-0000-00000HWE8		
		H0	18.1	68.2				XHGAWT-00-0000-00000PVE8	XHGAWT-00-0000-00000UVE8

- Notes
- Cree LED maintains a tolerance of ±7% on flux and power measurements, ±0.005 on chromaticity (CCx, CCy) measurements and a tolerance of ±2 on CRI measurements. See the Measurements section (page 17).
  - XLamp XH-G LED order codes specify only a minimum flux bin and not a maximum. Cree LED may ship reels in flux bins higher than the minimum specified by the order code without advance notice. Shipments will always adhere to the chromaticity bin restrictions specified by the order code.
  - Typical CRI for Neutral White, 3700 K - 5000 K CCT is 75.
  - Typical CRI for Warm White, 2600 K - 3700 K CCT is 80.
  - Minimum CRI for 70-CRI Minimum Cool White is 70.
  - Minimum CRI for 80-CRI Minimum White is 80.
  - Minimum CRI for 85-CRI Minimum White is 85.
  - Minimum CRI for 90-CRI Minimum White is 90.
  - \* Flux values @ 300 mA are calculated and for reference only.

RELATIVE SPECTRAL POWER DISTRIBUTION

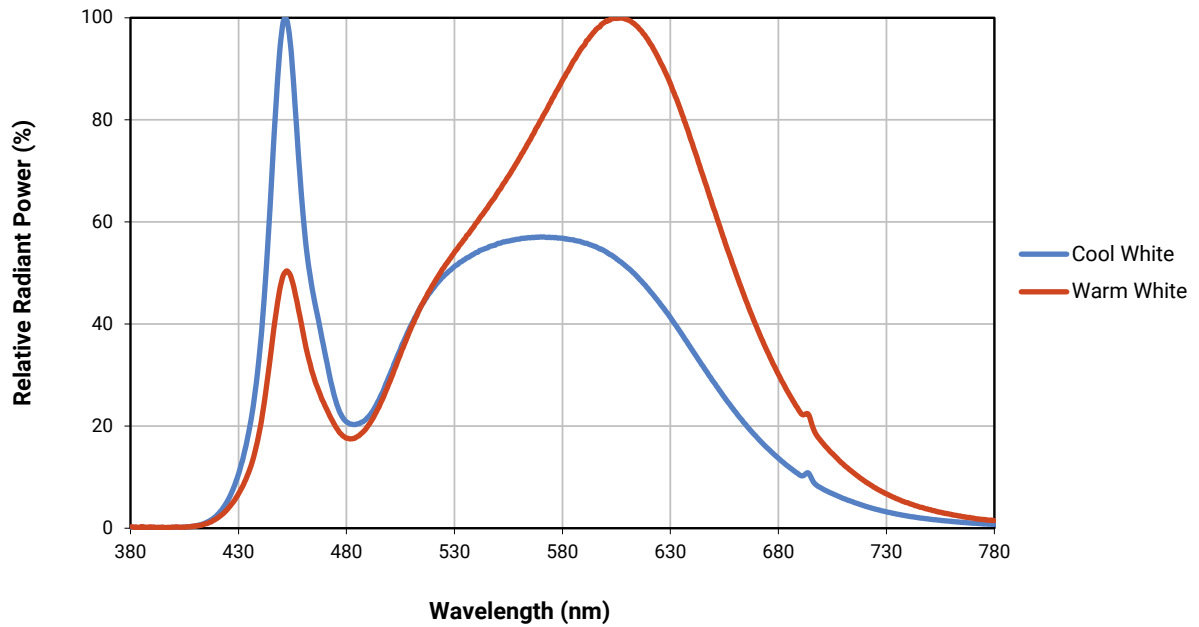

RELATIVE FLUX VS. JUNCTION TEMPERATURE ( $I_f = 65 \text{ mA}$ )

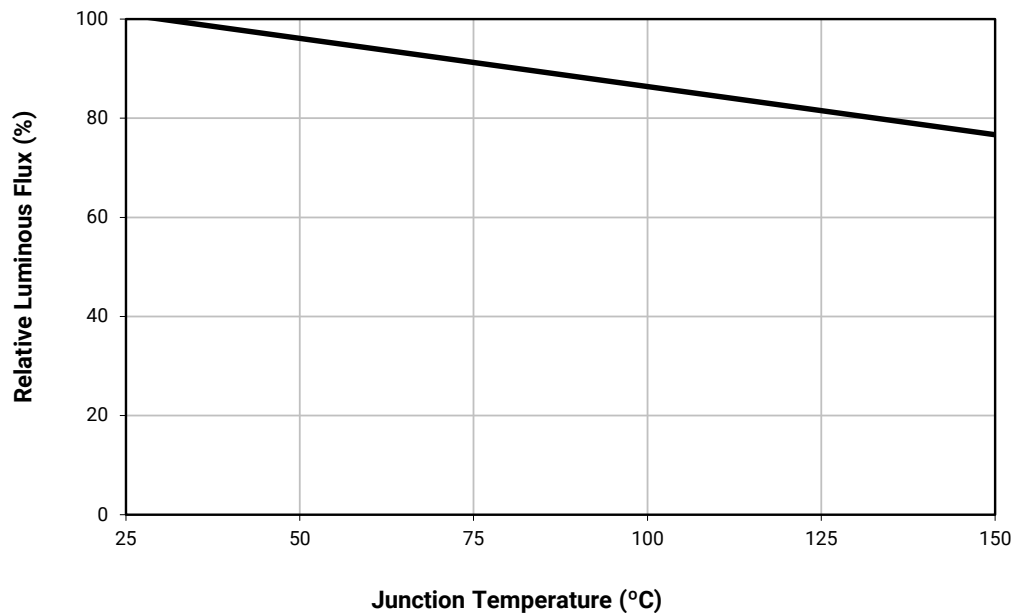

ELECTRICAL CHARACTERISTICS ( $T_j = 25\text{ }^\circ\text{C}$ )

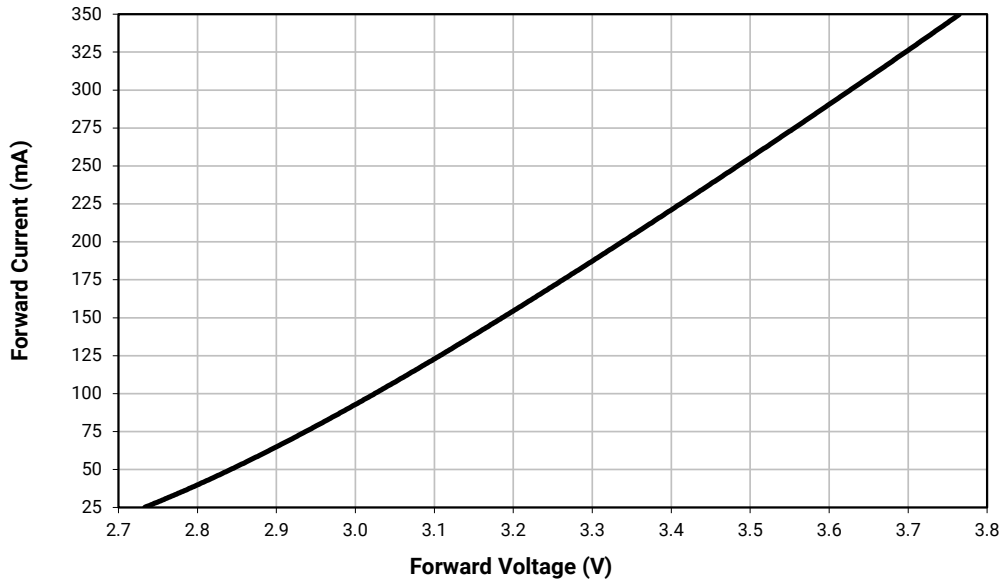

RELATIVE FLUX VS. CURRENT ( $T_j = 25\text{ }^\circ\text{C}$ )

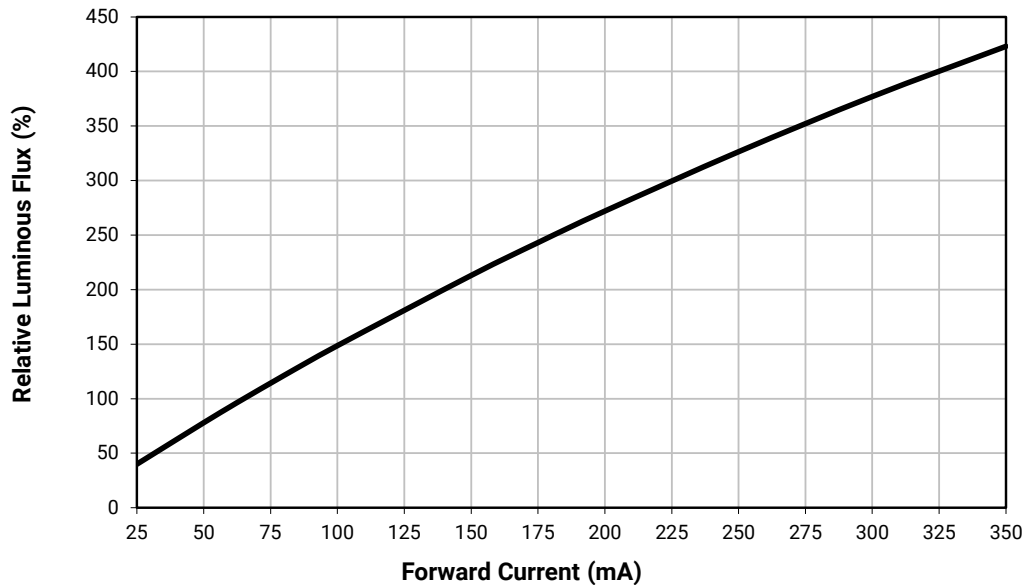

## TYPICAL SPATIAL DISTRIBUTION

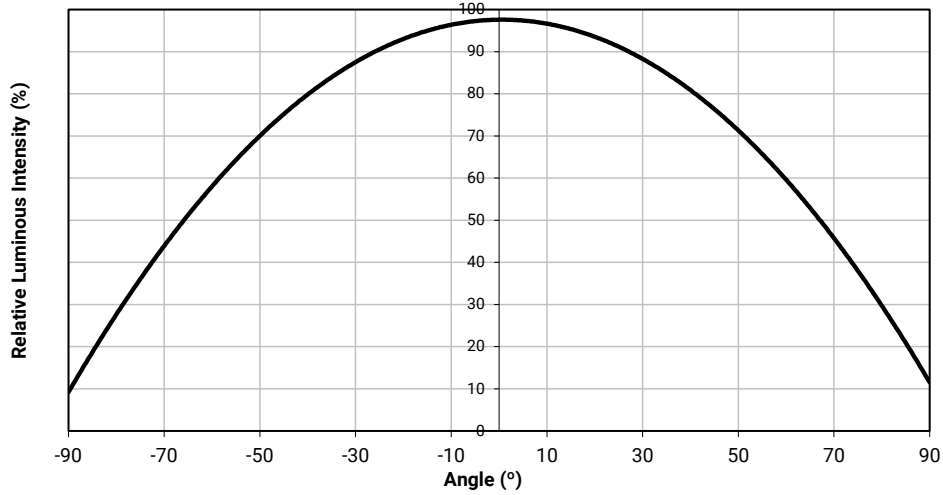

## THERMAL DESIGN

The maximum forward current is determined by the thermal resistance between the LED junction and ambient. It is crucial for the end product to be designed in a manner that minimizes the thermal resistance from the solder point to ambient in order to optimize lamp life and optical characteristics.

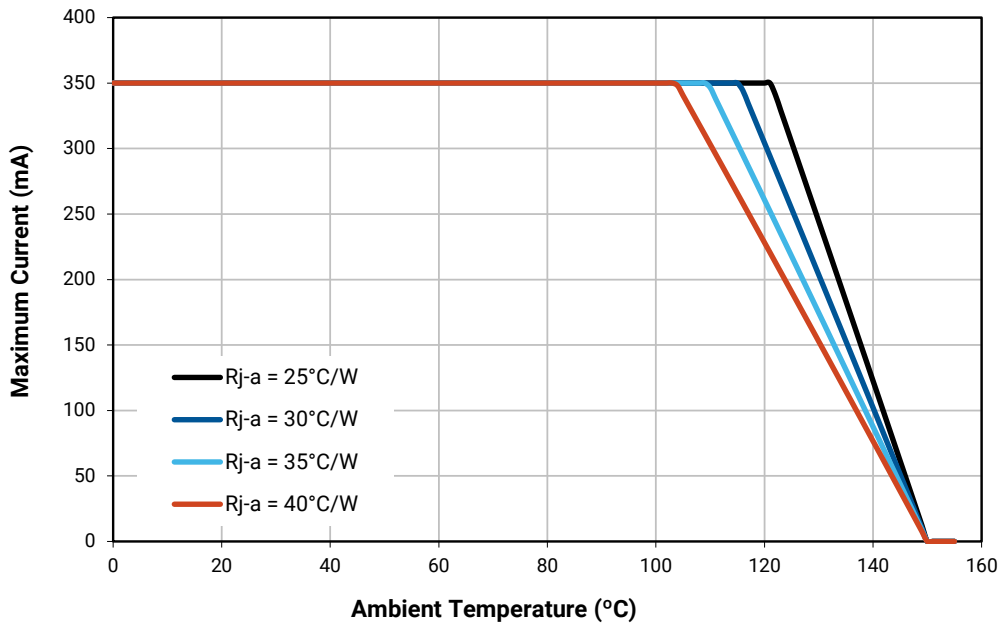



### PERFORMANCE GROUPS – LUMINOUS FLUX ( $T_j = 25\text{ }^\circ\text{C}$ )

XLamp XH-G LEDs are tested for luminous flux and placed into one of the following luminous-flux groups. These group codes, with a 0 appended, are used in the Bin Code “Luminous flux group.”

Group Code	Minimum Luminous Flux (lm)	Maximum Luminous Flux (lm)
H0	18.1	23.5
J2	23.5	26.8
J3	26.8	30.6
K2	30.6	35.2
K3	35.2	39.8

### PERFORMANCE GROUPS – CHROMATICITY

XLamp XH-G LEDs are tested for chromaticity and placed into one of the following chromaticity groups. These group codes are used in the Bin Code “Chromaticity bin.” Two-digit group codes are appended with a 0.

Region	x	y	Region	x	y	Region	x	y	Region	x	y
0A	0.2950	0.2970	0B	0.2920	0.3060	0C	0.2984	0.3133	0D	0.2984	0.3133
	0.2920	0.3060		0.2895	0.3135		0.2962	0.3220		0.3048	0.3207
	0.2984	0.3133		0.2962	0.3220		0.3028	0.3304		0.3068	0.3113
	0.3009	0.3042		0.2984	0.3133		0.3048	0.3207		0.3009	0.3042
0R	0.2980	0.2880	0S	0.2895	0.3135	0T	0.2962	0.3220	0U	0.3037	0.2937
	0.2950	0.2970		0.2870	0.3210		0.2937	0.3312		0.3009	0.3042
	0.3009	0.3042		0.2937	0.3312		0.3005	0.3415		0.3068	0.3113
	0.3037	0.2937		0.2962	0.3220		0.3028	0.3304		0.3093	0.2993
1A	0.3048	0.3207	1B	0.3028	0.3304	1C	0.3115	0.3391	1D	0.3130	0.3290
	0.3130	0.3290		0.3115	0.3391		0.3205	0.3481		0.3213	0.3373
	0.3144	0.3186		0.3130	0.3290		0.3213	0.3373		0.3221	0.3261
	0.3068	0.3113		0.3048	0.3207		0.3130	0.3290		0.3144	0.3186
1R	0.3068	0.3113	1S	0.3005	0.3415	1T	0.3099	0.3509	1U	0.3144	0.3186
	0.3144	0.3186		0.3099	0.3509		0.3196	0.3602		0.3221	0.3261
	0.3161	0.3059		0.3115	0.3391		0.3205	0.3481		0.3231	0.3120
	0.3093	0.2993		0.3028	0.3304		0.3115	0.3391		0.3161	0.3059
2A	0.3215	0.3350	2B	0.3207	0.3462	2C	0.3290	0.3538	2D	0.3290	0.3417
	0.3290	0.3417		0.3290	0.3538		0.3376	0.3616		0.3371	0.3490
	0.3290	0.3300		0.3290	0.3417		0.3371	0.3490		0.3366	0.3369
	0.3222	0.3243		0.3215	0.3350		0.3290	0.3417		0.3290	0.3300
2R	0.3222	0.3243	2S	0.3196	0.3602	2T	0.3290	0.3690	2U	0.3290	0.3300
	0.3290	0.3300		0.3290	0.3690		0.3381	0.3762		0.3366	0.3369
	0.3290	0.3180		0.3290	0.3538		0.3376	0.3616		0.3361	0.3245
	0.3231	0.3120		0.3207	0.3462		0.3290	0.3538		0.3290	0.3180

PERFORMANCE GROUPS – CHROMATICITY (CONTINUED)

Region	x	y	Region	x	y	Region	x	y	Region	x	y
3A	0.3371	0.3490	3B	0.3376	0.3616	3C	0.3463	0.3687	3D	0.3451	0.3554
	0.3451	0.3554		0.3463	0.3687		0.3551	0.3760		0.3533	0.3620
	0.3440	0.3427		0.3451	0.3554		0.3533	0.3620		0.3515	0.3487
	0.3366	0.3369		0.3371	0.3490		0.3451	0.3554		0.3440	0.3427
3R	0.3366	0.3369	3S	0.3381	0.3762						
	0.3440	0.3428		0.3480	0.3840						
	0.3429	0.3307		0.3463	0.3687						
	0.3361	0.3245		0.3376	0.3616						
4A	0.3530	0.3597	4B	0.3548	0.3736	4C	0.3641	0.3804	4D	0.3615	0.3659
	0.3615	0.3659		0.3641	0.3804		0.3736	0.3874		0.3702	0.3722
	0.3590	0.3521		0.3615	0.3659		0.3702	0.3722		0.3670	0.3578
	0.3512	0.3465		0.3530	0.3597		0.3615	0.3659		0.3590	0.3521
5A1	0.3670	0.3578	5A2	0.3686	0.3649	5A3	0.3744	0.3685	5A4	0.3726	0.3612
	0.3686	0.3649		0.3702	0.3722		0.3763	0.3760		0.3744	0.3685
	0.3744	0.3685		0.3763	0.3760		0.3825	0.3798		0.3804	0.3721
	0.3726	0.3612		0.3744	0.3685		0.3804	0.3721		0.3783	0.3646
5B1	0.3702	0.3722	5B2	0.3719	0.3797	5B3	0.3782	0.3837	5B4	0.3763	0.3760
	0.3719	0.3797		0.3736	0.3874		0.3802	0.3916		0.3782	0.3837
	0.3782	0.3837		0.3802	0.3916		0.3869	0.3958		0.3847	0.3877
	0.3763	0.3760		0.3782	0.3837		0.3847	0.3877		0.3825	0.3798
5C1	0.3825	0.3798	5C2	0.3847	0.3877	5C3	0.3912	0.3917	5C4	0.3887	0.3836
	0.3847	0.3877		0.3869	0.3958		0.3937	0.4001		0.3912	0.3917
	0.3912	0.3917		0.3937	0.4001		0.4006	0.4044		0.3978	0.3958
	0.3887	0.3836		0.3912	0.3917		0.3978	0.3958		0.3950	0.3875
5D1	0.3783	0.3646	5D2	0.3804	0.3721	5D3	0.3863	0.3758	5D4	0.3840	0.3681
	0.3804	0.3721		0.3825	0.3798		0.3887	0.3836		0.3863	0.3758
	0.3863	0.3758		0.3887	0.3836		0.3950	0.3875		0.3924	0.3794
	0.3840	0.3681		0.3863	0.3758		0.3924	0.3794		0.3898	0.3716
6A1	0.3889	0.3690	6A2	0.3915	0.3768	6A3	0.3981	0.3800	6A4	0.3953	0.3720
	0.3915	0.3768		0.3941	0.3848		0.4010	0.3882		0.3981	0.3800
	0.3981	0.3800		0.4010	0.3882		0.4080	0.3916		0.4048	0.3832
	0.3953	0.3720		0.3981	0.3800		0.4048	0.3832		0.4017	0.3751
6B1	0.3941	0.3848	6B2	0.3968	0.3930	6B3	0.4040	0.3966	6B4	0.4010	0.3882
	0.3968	0.3930		0.3996	0.4015		0.4071	0.4052		0.4040	0.3966
	0.4040	0.3966		0.4071	0.4052		0.4146	0.4089		0.4113	0.4001
	0.4010	0.3882		0.4040	0.3966		0.4113	0.4001		0.4080	0.3916
6C1	0.4080	0.3916	6C2	0.4113	0.4001	6C3	0.4186	0.4037	6C4	0.4150	0.3950
	0.4113	0.4001		0.4146	0.4089		0.4222	0.4127		0.4186	0.4037
	0.4186	0.4037		0.4222	0.4127		0.4299	0.4165		0.4259	0.4073
	0.4150	0.3950		0.4186	0.4037		0.4259	0.4073		0.4221	0.3984

PERFORMANCE GROUPS – CHROMATICITY (CONTINUED)

Region	x	y	Region	x	y	Region	x	y	Region	x	y
6D1	0.4017	0.3751	6D2	0.4048	0.3832	6D3	0.4116	0.3865	6D4	0.4082	0.3782
	0.4048	0.3832		0.4080	0.3916		0.4150	0.3950		0.4116	0.3865
	0.4116	0.3865		0.4150	0.3950		0.4221	0.3984		0.4183	0.3898
	0.4082	0.3782		0.4116	0.3865		0.4183	0.3898		0.4147	0.3814
7A1	0.4147	0.3814	7A2	0.4183	0.3898	7A3	0.4242	0.3919	7A4	0.4203	0.3833
	0.4183	0.3898		0.4221	0.3984		0.4281	0.4006		0.4242	0.3919
	0.4242	0.3919		0.4281	0.4006		0.4342	0.4028		0.4300	0.3939
	0.4203	0.3833		0.4242	0.3919		0.4300	0.3939		0.4259	0.3853
7B1	0.4221	0.3984	7B2	0.4259	0.4073	7B3	0.4322	0.4096	7B4	0.4281	0.4006
	0.4259	0.4073		0.4299	0.4165		0.4364	0.4188		0.4322	0.4096
	0.4322	0.4096		0.4364	0.4188		0.4430	0.4212		0.4385	0.4119
	0.4281	0.4006		0.4322	0.4096		0.4385	0.4119		0.4342	0.4028
7C1	0.4342	0.4028	7C2	0.4385	0.4119	7C3	0.4449	0.4141	7C4	0.4403	0.4049
	0.4385	0.4119		0.4430	0.4212		0.4496	0.4236		0.4449	0.4141
	0.4449	0.4141		0.4496	0.4236		0.4562	0.4260		0.4513	0.4164
	0.4403	0.4049		0.4449	0.4141		0.4513	0.4164		0.4465	0.4071
7D1	0.4259	0.3853	7D2	0.4300	0.3939	7D3	0.4359	0.3960	7D4	0.4316	0.3873
	0.4300	0.3939		0.4342	0.4028		0.4403	0.4049		0.4359	0.3960
	0.4359	0.3960		0.4403	0.4049		0.4465	0.4071		0.4418	0.3981
	0.4316	0.3873		0.4359	0.3960		0.4418	0.3981		0.4373	0.3893
8A1	0.4373	0.3893	8A2	0.4418	0.3981	8A3	0.4475	0.3994	8A4	0.4428	0.3906
	0.4418	0.3981		0.4465	0.4071		0.4523	0.4085		0.4475	0.3994
	0.4475	0.3994		0.4523	0.4085		0.4582	0.4099		0.4532	0.4008
	0.4428	0.3906		0.4475	0.3994		0.4532	0.4008		0.4483	0.3919
8B1	0.4465	0.4071	8B2	0.4513	0.4164	8B3	0.4573	0.4178	8B4	0.4523	0.4085
	0.4513	0.4164		0.4562	0.4260		0.4624	0.4274		0.4573	0.4178
	0.4573	0.4178		0.4624	0.4274		0.4687	0.4289		0.4634	0.4193
	0.4523	0.4085		0.4573	0.4178		0.4634	0.4193		0.4582	0.4099
8C1	0.4582	0.4099	8C2	0.4634	0.4193	8C3	0.4695	0.4207	8C4	0.4641	0.4112
	0.4634	0.4193		0.4687	0.4289		0.4750	0.4304		0.4695	0.4207
	0.4695	0.4207		0.4750	0.4304		0.4813	0.4319		0.4756	0.4221
	0.4641	0.4112		0.4695	0.4207		0.4756	0.4221		0.4700	0.4126
8D1	0.4483	0.3919	8D2	0.4532	0.4008	8D3	0.4589	0.4021	8D4	0.4538	0.3931
	0.4532	0.4008		0.4582	0.4099		0.4641	0.4112		0.4589	0.4021
	0.4589	0.4021		0.4641	0.4112		0.4700	0.4126		0.4646	0.4034
	0.4538	0.3931		0.4589	0.4021		0.4646	0.4034		0.4593	0.3944

STANDARD COOL WHITE KITS PLOTTED ON ANSI STANDARD CHROMATICITY REGIONS

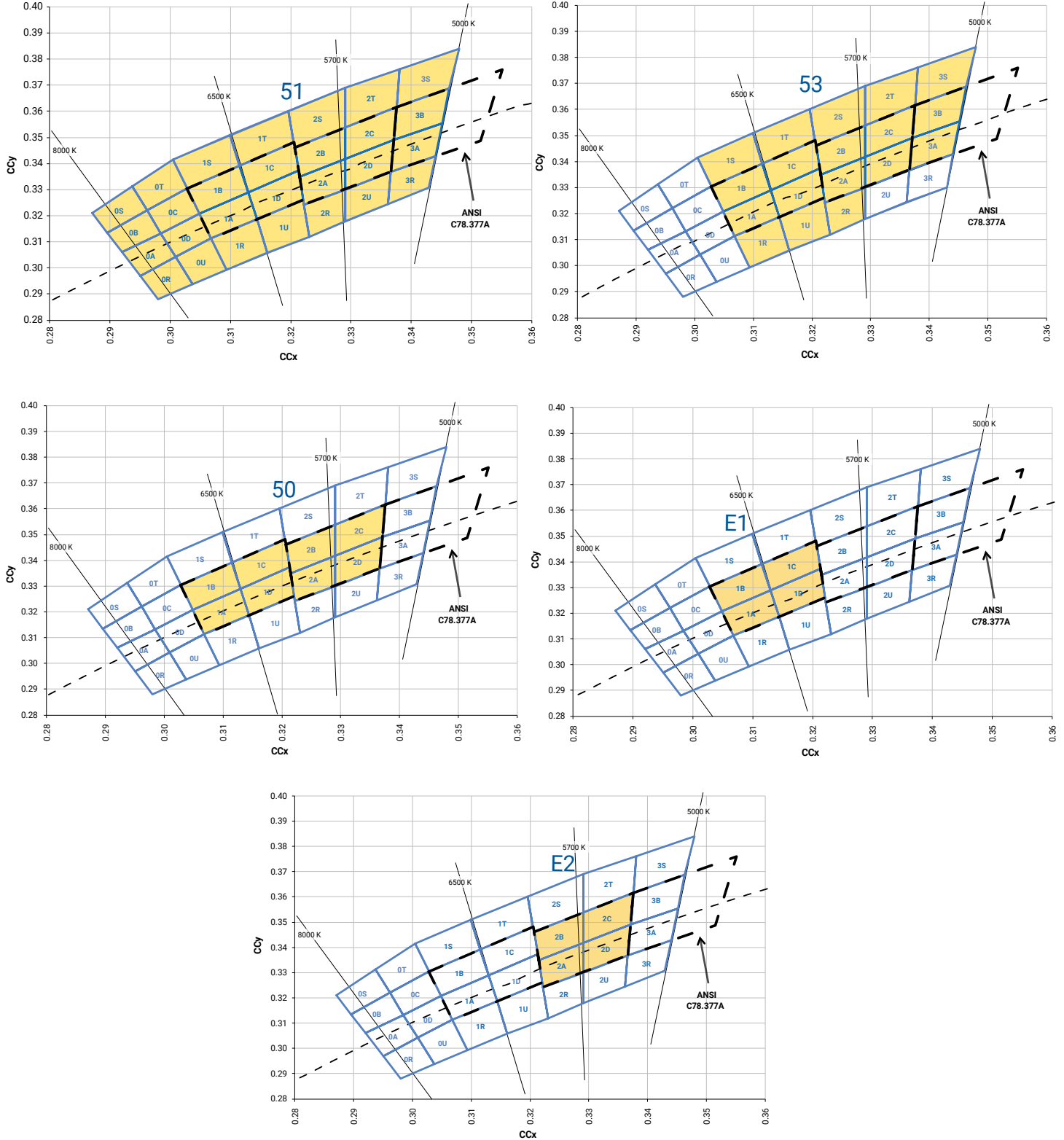

STANDARD WARM AND NEUTRAL WHITE KITS PLOTTED ON ANSI STANDARD CHROMATICITY REGIONS

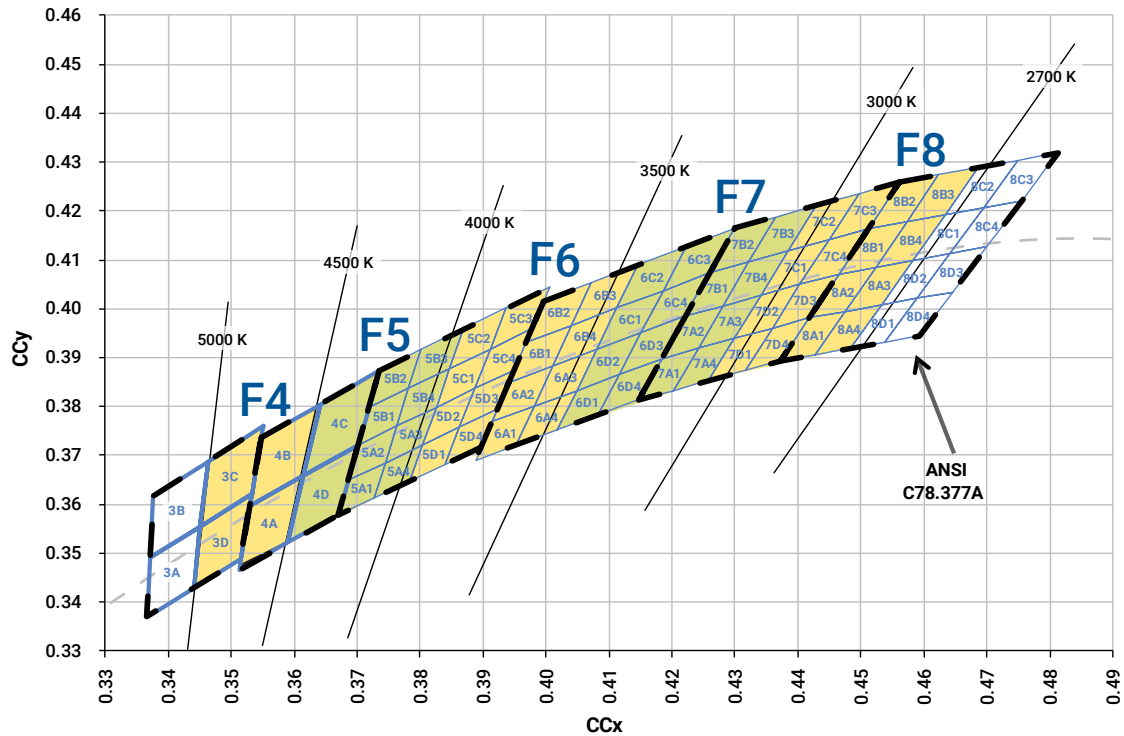
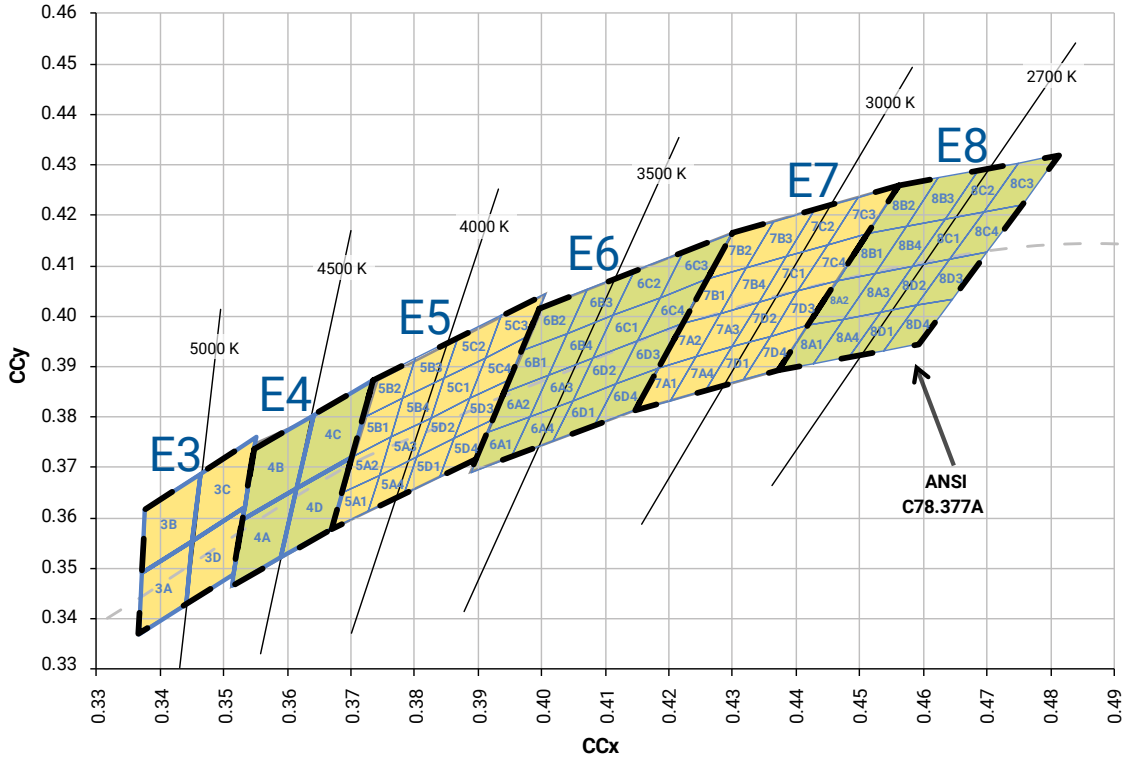

## STANDARD CHROMATICITY KITS

The following table provides the chromaticity bins associated with chromaticity kits.

Color	CCT	Kit	Chromaticity Bins
Cool White	6200 K	51	0A, 0B, 0C, 0D, 0R, 0S, 0T, 0U, 1A, 1B, 1C, 1D, 1R, 1S, 1T, 1U, 2A, 2B, 2C, 2D, 2R, 2S, 2T, 2U, 3A, 3B, 3R, 3S
	6000 K	53	1A, 1B, 1C, 1D, 1R, 1S, 1T, 1U, 2A, 2B, 2C, 2D, 2R, 2S, 2T, 3A, 3B, 3S
	6200 K	50	1A, 1B, 1C, 1D, 2A, 2B, 2C, 2D
	6500 K	E1	1A, 1B, 1C, 1D
	5700 K	E2	2A, 2B, 2C, 2D
Neutral White	5000 K	E3	3A, 3B, 3C, 3D
	4750 K	F4	3C, 3D, 4A, 4B
	4500 K	E4	4A, 4B, 4C, 4D
	4250 K	F5	4C, 4D, 5A1, 5A2, 5A3, 5A4, 5B1, 5B2, 5B3, 5B4
	4000 K	E5	5A1, 5A2, 5A3, 5A4, 5B1, 5B2, 5B3, 5B4, 5C1, 5C2, 5C3, 5C4, 5D1, 5D2, 5D3, 5D4
Warm White	3750 K	F6	5C1, 5C2, 5C3, 5C4, 5D1, 5D2, 5D3, 5D4, 6A1, 6A2, 6A3, 6A4, 6B1, 6B2, 6B3, 6B4
	3500 K	E6	6A1, 6A2, 6A3, 6A4, 6B1, 6B2, 6B3, 6B4, 6C1, 6C2, 6C3, 6C4, 6D1, 6D2, 6D3, 6D4
	3250 K	F7	6C1, 6C2, 6C3, 6C4, 6D1, 6D2, 6D3, 6D4, 7A1, 7A2, 7A3, 7A4, 7B1, 7B2, 7B3, 7B4
	3000 K	E7	7A1, 7A2, 7A3, 7A4, 7B1, 7B2, 7B3, 7B4, 7C1, 7C2, 7C3, 7C4, 7D1, 7D2, 7D3, 7D4
	2850 K	F8	7C1, 7C2, 7C3, 7C4, 7D1, 7D2, 7D3, 7D4, 8A1, 8A2, 8A3, 8A4, 8B1, 8B2, 8B3, 8B4
	2700 K	E8	8A1, 8A2, 8A3, 8A4, 8B1, 8B2, 8B3, 8B4, 8C1, 8C2, 8C3, 8C4, 8D1, 8D2, 8D3, 8D4

## BIN AND ORDER CODE FORMAT

Bin codes and order codes for XH-G LEDs are configured in the following manner:

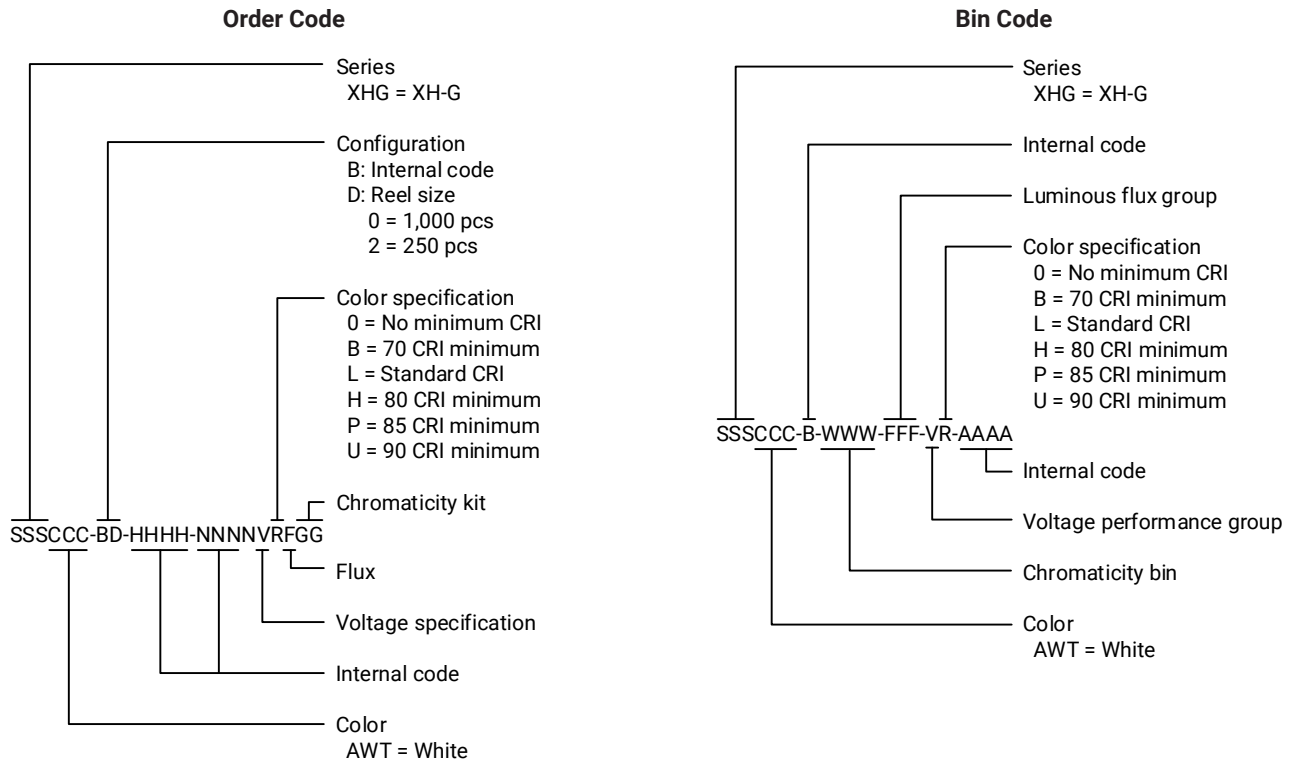

## REFLOW SOLDERING CHARACTERISTICS

In testing, Cree LED has found XLamp XH-G LEDs to be compatible with JEDEC J-STD-020C, using the parameters listed below. As a general guideline, Cree LED recommends that users follow the recommended soldering profile provided by the manufacturer of the solder paste used, and therefore it is the lamp or luminaire manufacturer’s responsibility to determine applicable soldering requirements.

Note that this general guideline may not apply to all PCB designs and configurations of reflow soldering equipment.

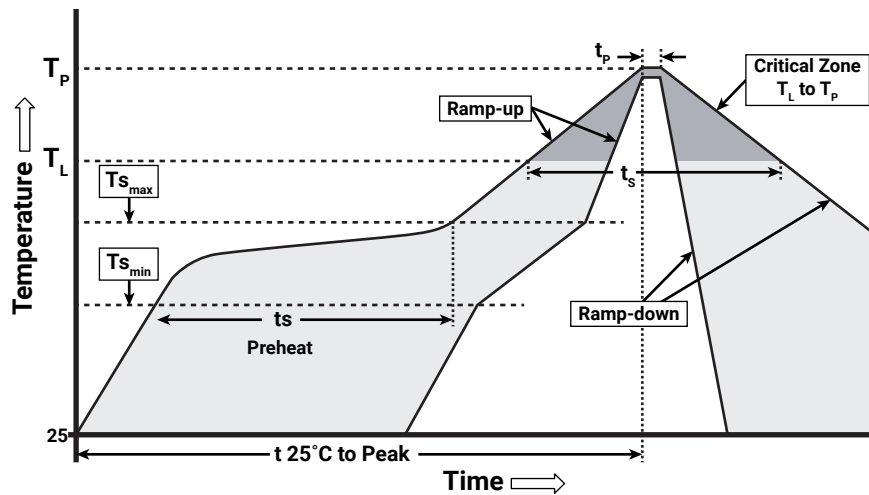

IPC/JEDEC J-STD-020C

Profile Feature	Lead-Free Solder
Average Ramp-Up Rate ( $T_{s_{max}}$ to $T_p$ )	1.2 °C/second
Preheat: Temperature Min ( $T_{s_{min}}$ )	120 °C
Preheat: Temperature Max ( $T_{s_{max}}$ )	170 °C
Preheat: Time ( $t_{s_{min}}$ to $t_{s_{max}}$ )	65-150 seconds
Time Maintained Above: Temperature ( $T_L$ )	217 °C
Time Maintained Above: Time ( $t_L$ )	45-90 seconds
Peak/Classification Temperature ( $T_p$ )	235 - 245 °C
Time Within 5 °C of Actual Peak Temperature ( $t_p$ )	20-40 seconds
Ramp-Down Rate	1 - 6 °C/second
Time 25 °C to Peak Temperature	4 minutes max.

Note: All temperatures refer to topside of the package, measured on the package body surface.



## NOTES

---

### Measurements

The luminous flux, radiant power, chromaticity, forward voltage and CRI measurements in this document are binning specifications only and solely represent product measurements as of the date of shipment. These measurements will change over time based on a number of factors that are not within Cree LED's control and are not intended or provided as operational specifications for the products. Calculated values are provided for informational purposes only and are not intended or provided as specifications.

### Pre-Release Qualification Testing

Please read the [LED Reliability Overview](#) for details of the qualification process Cree LED applies to ensure long-term reliability for XLamp LEDs and details of Cree LED's pre-release qualification testing for XLamp LEDs.

### Lumen Maintenance

Cree LED now uses standardized IES LM-80-08 and TM-21-11 methods for collecting long-term data and extrapolating LED lumen maintenance. For information on the specific LM-80 data sets available for this LED, refer to the public [LM-80 results document](#).

Please read the [Long-Term Lumen Maintenance application note](#) for more details on Cree LED's lumen maintenance testing and forecasting. Please read the [Thermal Management application note](#) for details on how thermal design, ambient temperature, and drive current affect the LED junction temperature.

### Moisture Sensitivity

Cree LED recommends keeping XLamp LEDs in the provided, resealable moisture-barrier packaging (MBP) until immediately prior to soldering. Unopened MBPs that contain XLamp LEDs do not need special storage for moisture sensitivity.

Once the MBP is opened, XLamp XH-G LEDs may be stored as MSL 1 per JEDEC J-STD-033, meaning they have unlimited floor life in conditions of  $\leq 30$  °C/85% relative humidity (RH). Regardless of storage condition, Cree LED recommends sealing any unsoldered LEDs in the original MBP.

### RoHS Compliance

The levels of RoHS restricted materials in this product are below the maximum concentration values (also referred to as the threshold limits) permitted for such substances, or are used in an exempted application, in accordance with EU Directive 2011/65/EC (RoHS2), as implemented January 2, 2013. RoHS Declarations for this product can be obtained from your Cree LED representative or from the [Product Ecology](#) section of the Cree LED website.

### REACH Compliance

REACH substances of very high concern (SVHCs) information is available for this product. Since the European Chemical Agency (ECHA) has published notice of their intent to frequently revise the SVHC listing for the foreseeable future, please contact a Cree LED representative to insure you get the most up-to-date REACH SVHC Declaration. REACH banned substance information (REACH Article 67) is also available upon request.

## NOTES - CONTINUED

---

### **UL® Recognized Component**

This product meets the requirements to be considered a UL Recognized Component with Level 4 enclosure consideration. The LED package or a portion thereof has been investigated as a fire and electrical enclosure per ANSI/UL 8750.

### **Vision Advisory**

WARNING: Do not look at an exposed lamp in operation. Eye injury can result. For more information about LEDs and eye safety, please refer to the [LED Eye Safety application note](#).

## MECHANICAL DIMENSIONS

All dimensions are  $\pm 0.13$  mm unless otherwise indicated.

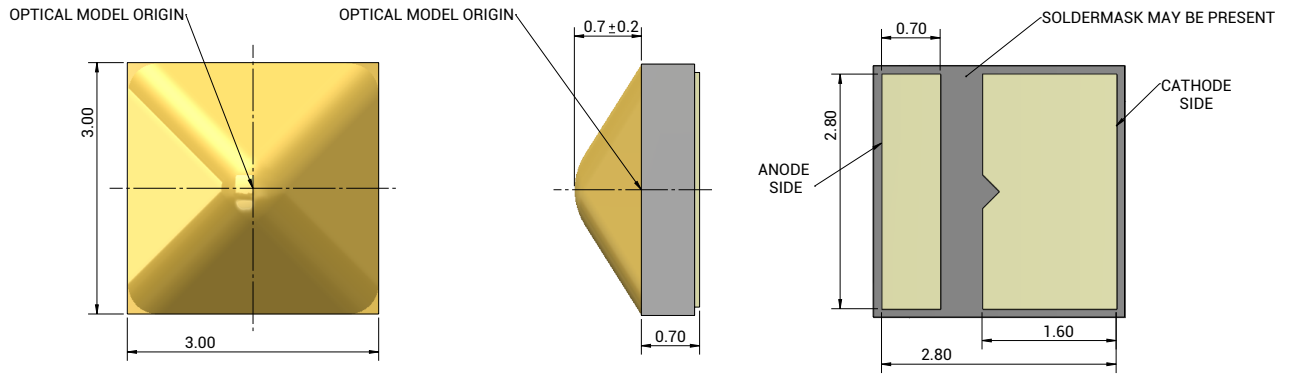

**Top View**

**Side View**

**Bottom View**

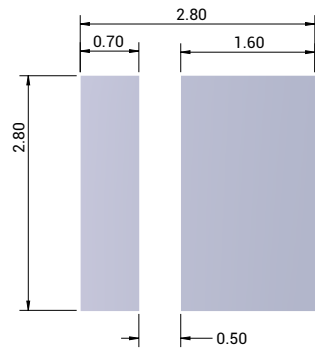

**Recommended PCB Footprint**

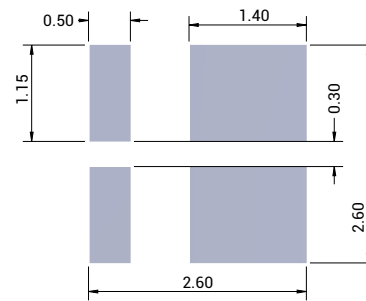

**Recommended Stencil Opening**

## TAPE AND REEL

All Cree LED carrier tapes conform to EIA-481D, Automated Component Handling Systems Standard.

All dimensions are  $\pm 0.13$  mm unless otherwise indicated.

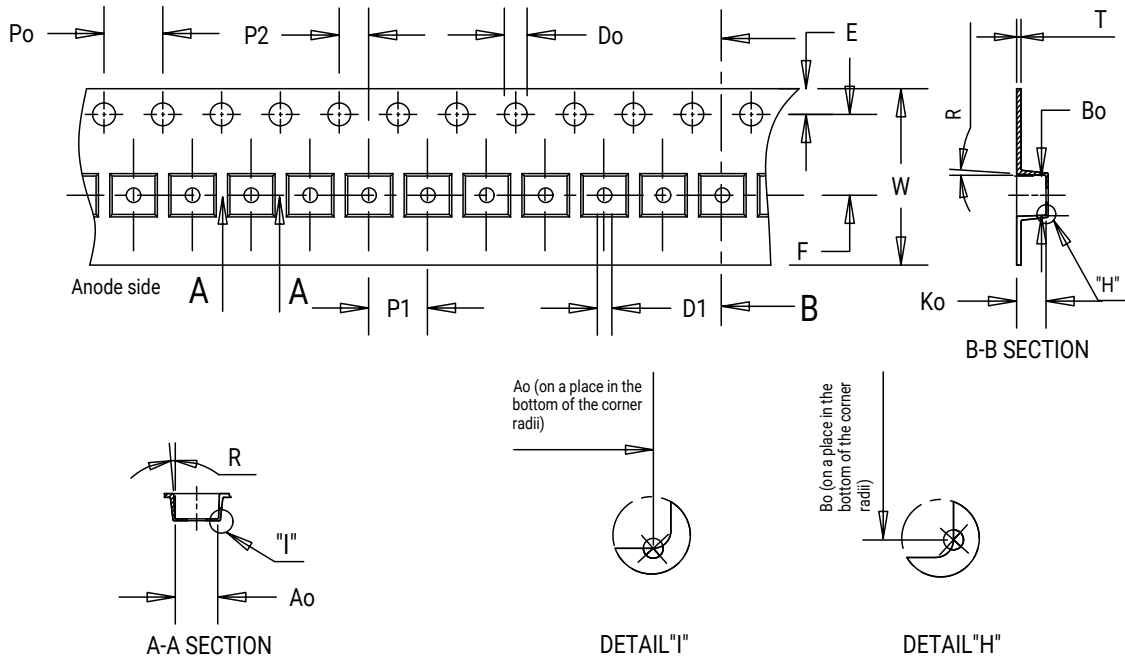

Item	Ao	Bo	Ko	Po	P1	P2	T	E	F	Do	D1	W	R
Dim.	3.30	3.30	1.55	4.00	8.00	2.00	0.30	1.75	5.50	1.50	1.50	12.00	3°

TAPE AND REEL - CONTINUED

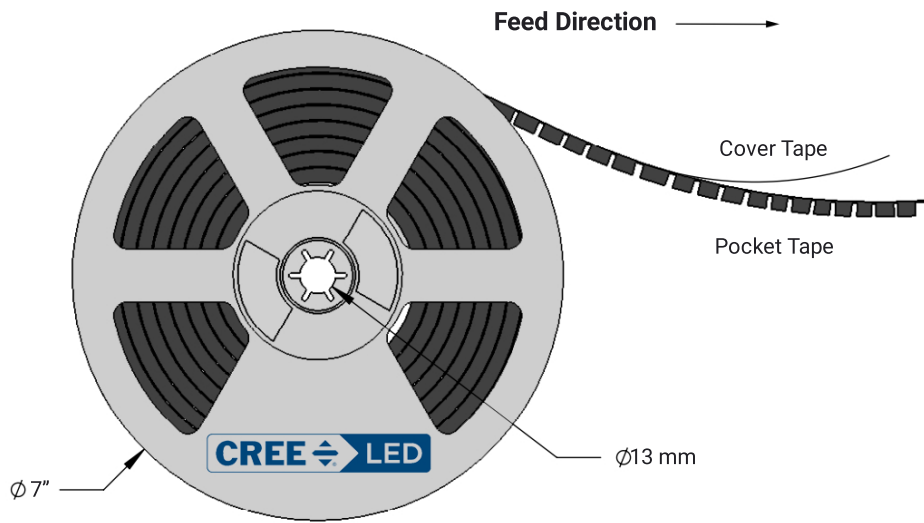
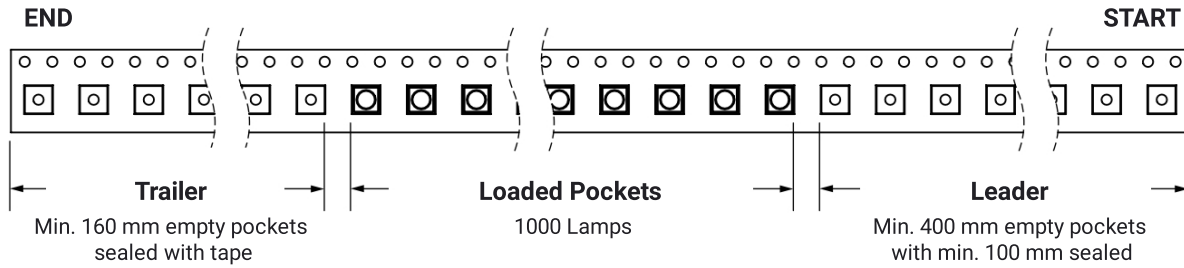

**PACKAGING**

The diagrams below show the packaging and labels Cree LED uses to ship XLamp XH-G LEDs. XLamp XH-G LEDs are shipped in tape loaded on a reel. Each box contains only one reel in a moisture barrier bag.

**Unpackaged Reel**

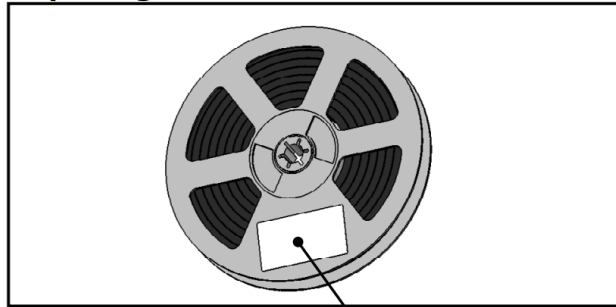

Label with Cree LED Bin Code, Quantity, Reel ID

**Packaged Reel**

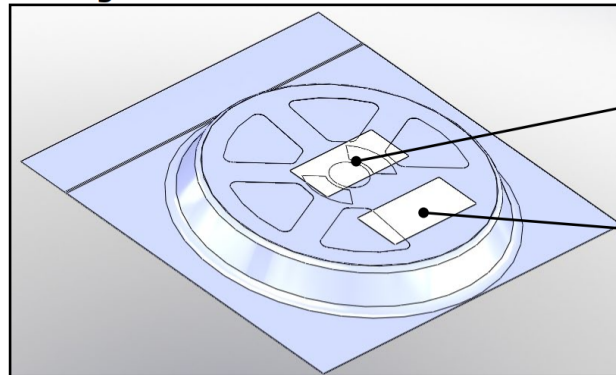

Label with Cree LED Order Code, Quantity, Reel ID, PO#

Label with Cree LED Bin Code, Quantity, Reel ID

**Boxed Reel**

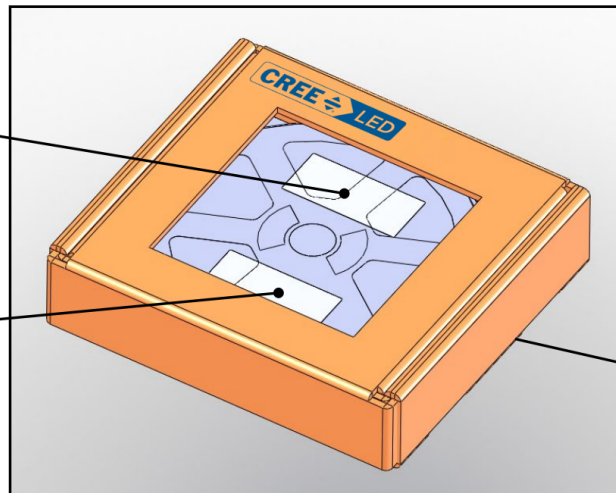

Label with Cree LED Order Code, Quantity, Reel ID, PO#

Label with Cree LED Bin Code, Quantity, Reel ID

Patent Label (on bottom of box)